

MAF302D / M series

AIR UNIT (MIST / MICRO MIST FILTER)



mindman



Symbol

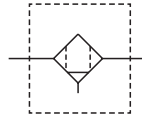

D: 0.3µm

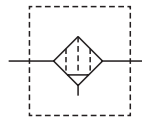

M: 0.01µm

- MA302D is designed for removal of foreign matter as well as oil mist (Element: 0.3µm)
- MA302M is designed for removal of foreign matter as well as oil mist (Element: 0.01µm)

Specification

Model	MAF302D/M		
Bore No.	8A	10A	15A
Port size	1/4	3/8	1/2
Medium	Air		
Operating pressure range (*)	0.05~1 MPa		
Proof pressure	1.5 MPa		
Ambient temperature	- 5~+60°C (No freezing)		
Filter element	0.3 µm, 0.01 µm		
Drain capacity	35 cm ³		
Weight	365 g		

* Standard unit contains semi-auto-drain function when operating pressure below 0.05 MPa.

* Choose auto-drain FMRF300, the pressure range is 0.15~1 MPa.

Order example

MAF302D – 8A – ND□ – B – □

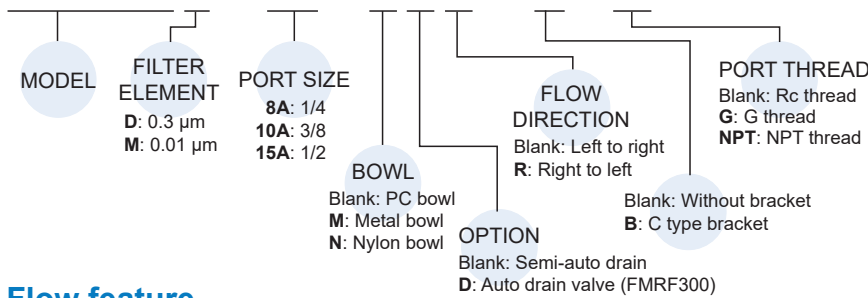

Flow feature

MAF302D (Filter element: 0.3 µm)

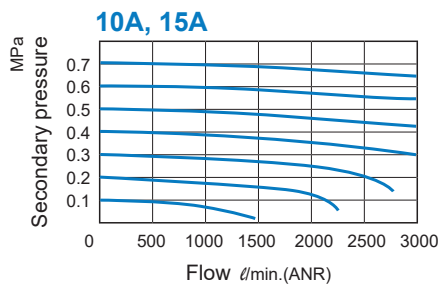
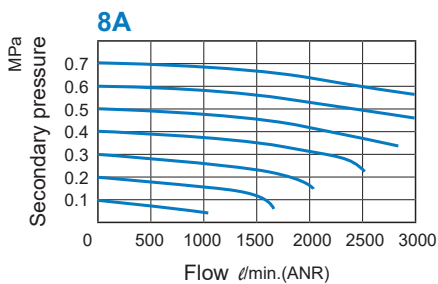

MAF302M (Filter element: 0.01 µm)

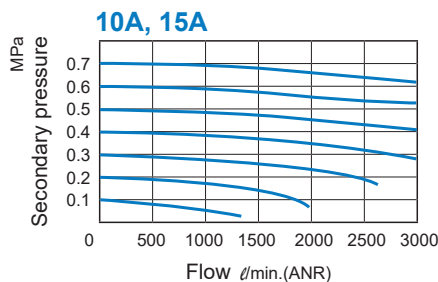
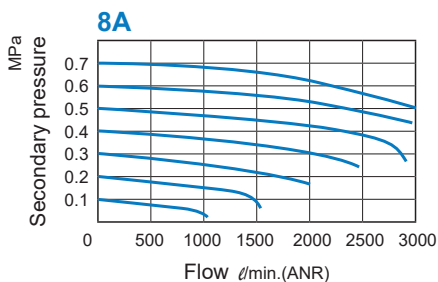

Option accessories

C type bracket

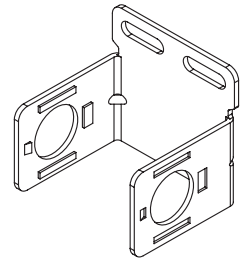

Caution

Metal bowl

Before assembling or disassembling, push the lock plate down to the end, and confirm that is detached from the body then rotate the bowl, otherwise the lock plate will be deformed or the body will be scratched.

1. Sliding plate down
2. Rotating the bowl

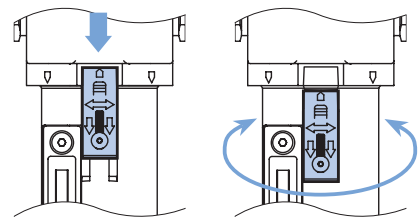

MAF302D / M Dimensions

AIR UNIT (MIST / MICRO MIST FILTER)



mindman

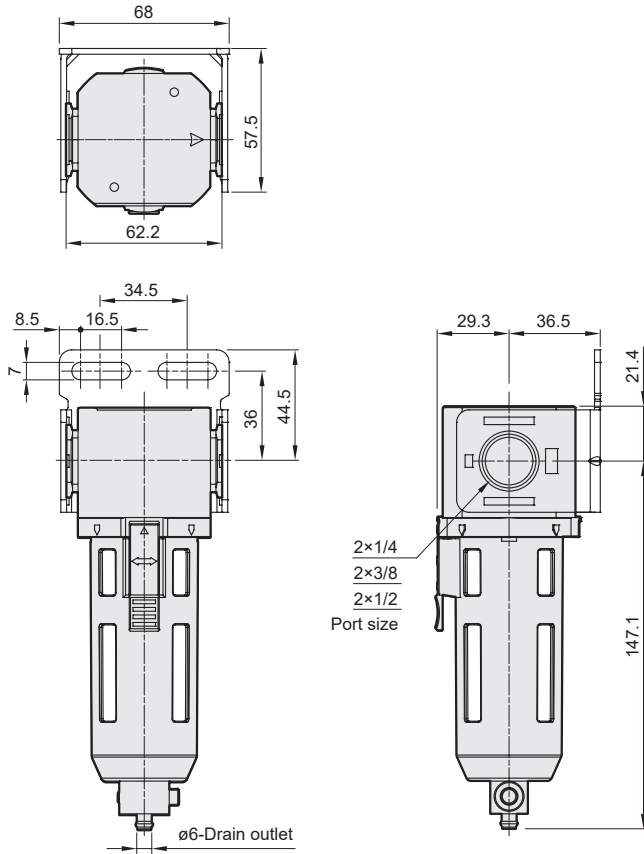

MAF302D/M-D

Auto drain valve

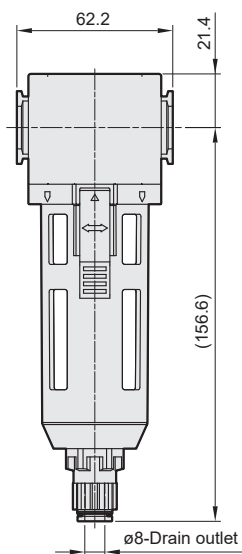

MAF302D/M-M

Metal bowl

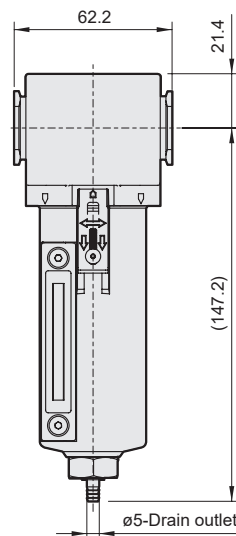

MAF302D/M-MD

Metal bowl + Auto drain valve

